

# **U-Storage User's Manual**



**Version 2.5**

## Introduction

Thank you for purchasing the U-Storage device. The manual explains how to use the U-Storage software bundled with the device.

## Safety Precautions

Please follow the safety precautions carefully before you use the U-Storage device and the application software (the product). Make sure that you use the product correctly according to the procedures described in this guide.



### Warnings

This mark indicates topics that could lead to serious injury of your body or damage of the product if ignored or handled incorrectly.



### Warnings

- Do not attempt to disassemble or alter any part of the product that is not described in this guide.
- Do not allow the product to come into contact with water or other liquids. In the event that water or other liquids enter the interior, immediately unplug the product from the computer. Continued use of the product may result in fire or electrical shock. Please consult your product distributor or the closest support center.
- Do not handle the product to do the plug and unplug operation if your hands are wet. Otherwise it will cause electrical shock.
- Do not place the product near a heat source or expose them to direct flame or heat.
- Never place the product close to equipment generating strong electromagnetic fields. Exposure to strong magnetic fields may cause malfunctions or corrupt data.

## System Requirements

There are minimum hardware and software requirements that must be satisfied to ensure the product to function properly.

- Computer Model            IBM PC/AT Compatible, Power Macintosh, PowerBook, iMAC or iBook
  
  - OS                            Windows 98 Second Edition, Windows Millennium Edition (Windows ME), Windows 2000, Windows XP
  
  - Interface                    USB
  
  - Free Hard Disk Space    3 MB and more
- 
- Windows 98 SE does not support default Mass Storage Driver. You have to install the driver bundled with the product.
  
  - The product can use the default driver in most of the OS. If you want to run the application software bundled with the product, install the vendor driver by the “U-StorageTools2.0.exe” utility. Then, the application software will work properly.
  
  - The application software only can run with Microsoft Windows OS.
  
  - However, the U-Storage basic functions can be supported in all OS listed above.

## Guide to Components

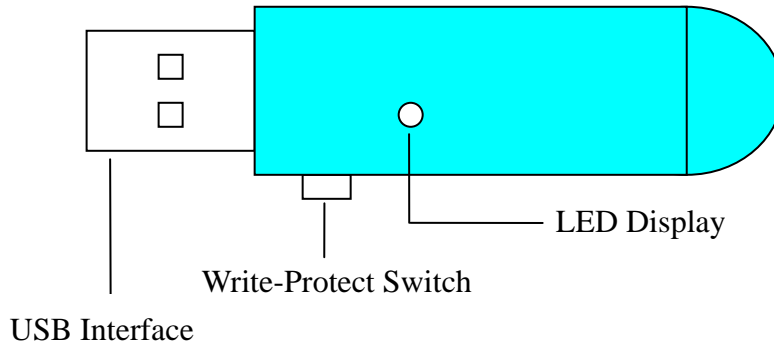

**USB Interface:** The interface connects to the USB port of the computer.

**Write-Protect Switch:** If you put the switch at “ON” position, the device will be in the write protect mode.

**LED Display:** This LED Display will show the status of the device. Once the device is in operation, the LED will be turned on.

## Basic Functions

### 1. Plug and Play

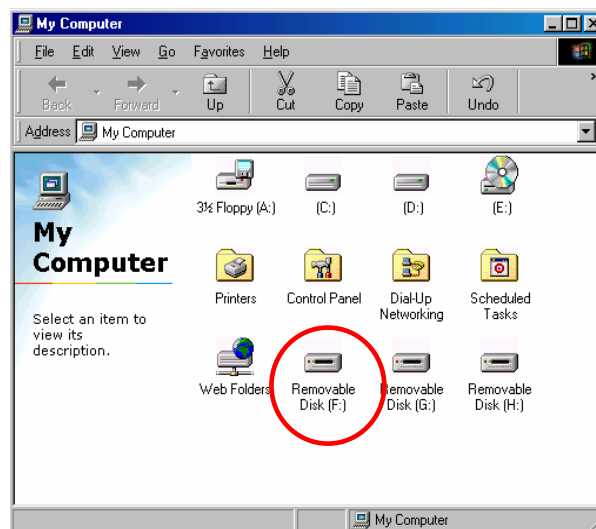

When you plug the device into the USB port of your computer, you will see a “Removable Disk” icon in the file manager window.

In **Macintosh**, once you plug the U-Storage into the USB port. You can see the disk icon in the “Desktop”.

In **Linux** OS, you can mount the device by the following instruction.

- Execute `cd /etc/sysconfig/ ( cat /etc/sysconfig/hwconf | more )`
- Check the device information in `hwconf` , write down the mount point.
- Make a directory in `/mnt` (ex: `mkdir /mnt/usbHD` )
- Then, execute `mount /dev/sda1 /mnt/usbHD` (if mount point was `.dev/sda`)

## 2. Read and Write

You can retrieve or store files in the device as a hard disk. The read/write operation of the device is the same as that of a hard disk.

## 3. Write-Protect Switch

When you put the write-protect switch to “ON” position, you cannot write any file or data into the device. You still can view and read the files and data in the device. You can switch the “Write-Protect” switch even you do not disconnect the device. Due to Linux OS limitation, the write-protect switch will not work on-line.

## 4. Unplug

You can remove the device after you finish the action with the device. However, in Windows ME and Windows 2000, please follow the safe removal procedure. You can find a safe removal icon in your computer’s notification area.



Double click the “safe removal” icon; the “Unplug or Eject Hardware” window will be pop up. You can select the device you want to remove. Then, click the “Stop” button. After that you can unplug the device from the USB port of your computer.



### **Warning**

When you want to remove the U-Storage device, make sure the LED is not flashing. When the LED flashes

quickly, there are some traffic on going between the OS and the U-Storage device. Don't remove the U-Storage at this moment. Otherwise, it will cause some damages to the data or even the U-Storage device itself.

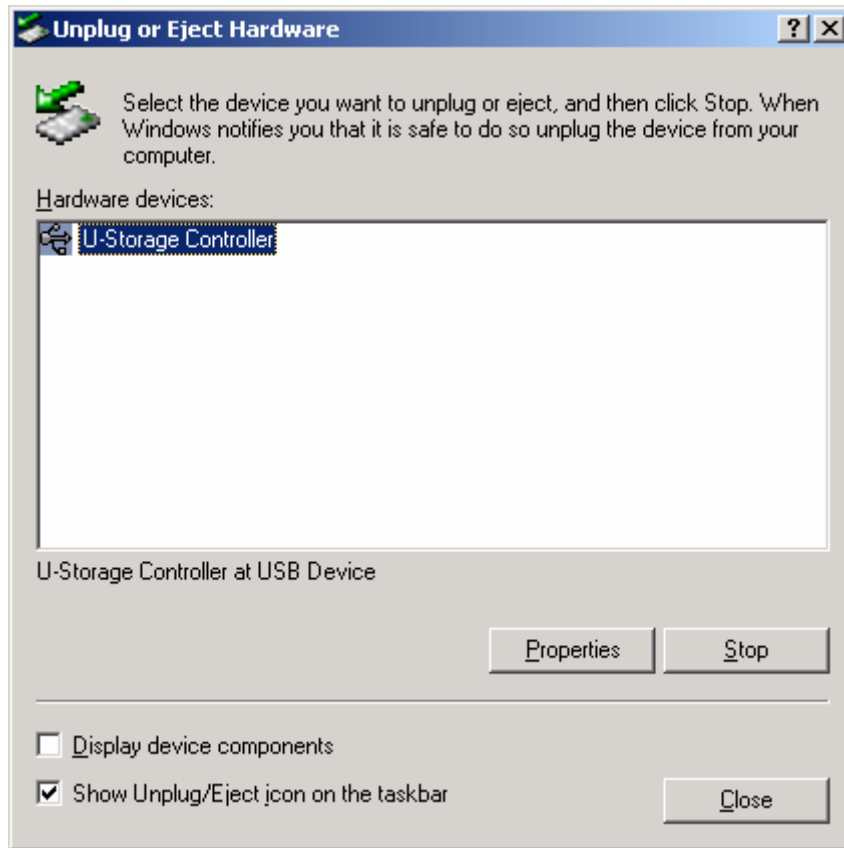

### **Warning**

If you do not follow the safe removal procedure in Windows ME and Windows 2000 systems, data loss caused by the “write cache” issue may happen.

In Macintosh systems, you can drag the removable disk icon and put into the trash. This action will perform the “Eject” function.

In Linux OS, please follow the “umount” command procedure to un-mount the device.

## Partition Type

The U-Storage may be partitioned into three types of disk. We will use the following terms in this guide,

1. Public Area                      There is no “Security” function at all. You can do any basic functions, described in the “Basic Functions” section, in this area.

2. Security Area                      This area cannot be viewed without the application software. Once you do the “Log In” action in the application software, you will switch view from “Public Area” to “Security Area”. After successful switch, you can do any basic functions, described in the “Basic Functions” section, in this area.



☞ You can only view either “Public Area” or “Security Area” at the same time in the same disk logic unit number (LUN).

In U-Storage, you can select the following partition combinations:

1. Single Public Area                      Make all the device area accessible by everybody.
2. Security Area                      Make the device area into two partitions in the same LUN, Public Area and Security Area. Everybody can access the Public Area. The Security Area can be accessed “Only” with a password.
3. Public Area Plus Security Area                      Make the device area into three partitions in two LUNs, Public Area and Security Area in LUN0, and Public Area in LUN1. You can access these partitions by the multiple-LUN driver. The partition status was shown in the following figure. The partitions in LUN 0 will perform as described in item 2. The partition in LUN 1 will perform as described in item1.

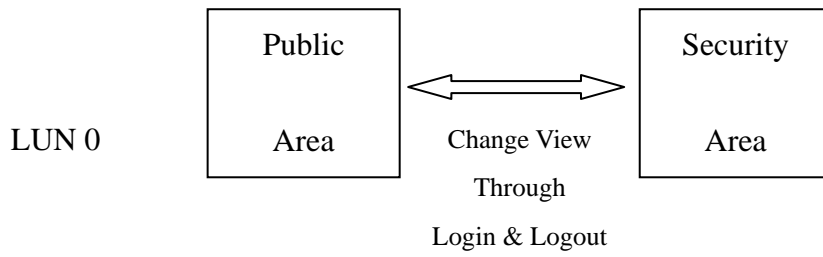

This figure shows detailed operations of single LUN

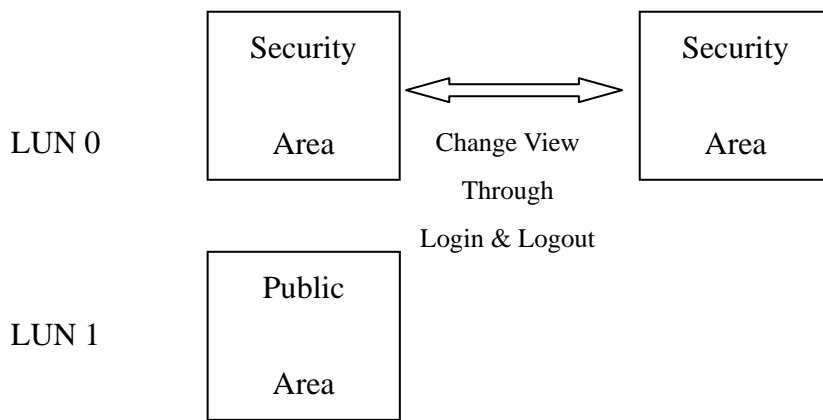

This figure shows detailed operations of multiple LUNs

Type	Function	Security	Password	Disk Logical Unit Number	Disk Letters in OS
1. Public Area Only		No	No	1 (LUN0)	1
2. Security Area		Yes	Yes	1 (LUN0)	1
3. Public Area Plus Security Area		Yes	Yes	2 (LUN0 & LUN1)	2

This table describes the functions of the three partition types

## **Using the Software**

### **On the Windows Platform**

#### **Installing/Uninstalling the Application Software:**

##### **Installing the software:**

If you are installing the application software onto Windows OS, you must first log on as the administrator and then install the application software.

##### Precaution about the USB Interface

- Please connect the device to the USB port of your computer when you install the application software.
- If you do not connect the device to the USB port and install the application software in the Microsoft Windows XP, you have to install the U-Storage driver again as you plug in the device.
- In Windows 98 SE and Win Me, you need to unplug the U-Storage and plug again after install the driver.

1. Find the “U-StorageTools.exe” program.  
You can find the program in the U-Storage, CD-ROM, or Floppy.
2. Double-click the [U-StorageTools.exe] icon.
3. Follow the on-screen instructions to proceed.

##### **Uninstalling the software:**

To remove the installed software, you can click the windows [Start] menu and select [Setting], [Control Panel] and [Add/Remove Programs]. The application software can also be uninstalled by clicking the [Start] menu and selecting [Programs], [U-Storage], [Uninstall U-Storage].

##### **Notes:**

- The USB driver will be required to install, as the device links the PC by the USB port at the first connection. After then, the drive installation is not required.
- Do not cancel the installation during the procedure. The U-Storage may not

operate correctly if the installation is incomplete.

- Read the “Troubleshooting” Section if the installation cancels itself during the procedure, if the installation did not proceed as described, or if you feel that the driver are not properly installed.

### **Installing the USB Driver:**

For some Windows system, users should log on as the Administrator before installation. Once you have attached the U-Storage to the computer. The OS will find the appropriate driver or the “Add New Hardware Wizard” dialog will appear after a moment. You can do the installation of the Driver manually. Or just find out the “Setup.exe” program to do the driver installation.

During the installation procedure, if the “Digital Signature Not Found” message displays, just click the [Yes] button in the showing window.

### **Using U-Storage.exe Program the First Time:**



#### **Warning**

Due to the U-Storage.exe can only handle one U-Storage device at the same time. If you will not use the function of the U-Storage.exe, like “Resize”, “Change Password”, or “Log In”, etc., you can insert more than two U-Storage devices. If you want to use the function of the program, remove all other U-Storage device. Otherwise, the U-Storage.exe may not perform properly or even cause data loss.

After you install the software and driver correctly, the U-Storage icon will appear at the notification area automatically.



Or



The display will depend on the status of the device.

- You can use the right button of your mouse to pop up the selection menus as the following figures. Then, you can select the functions you want.



- Or you can double click the icon in the notification window. The U-Storage manager window will pop up as

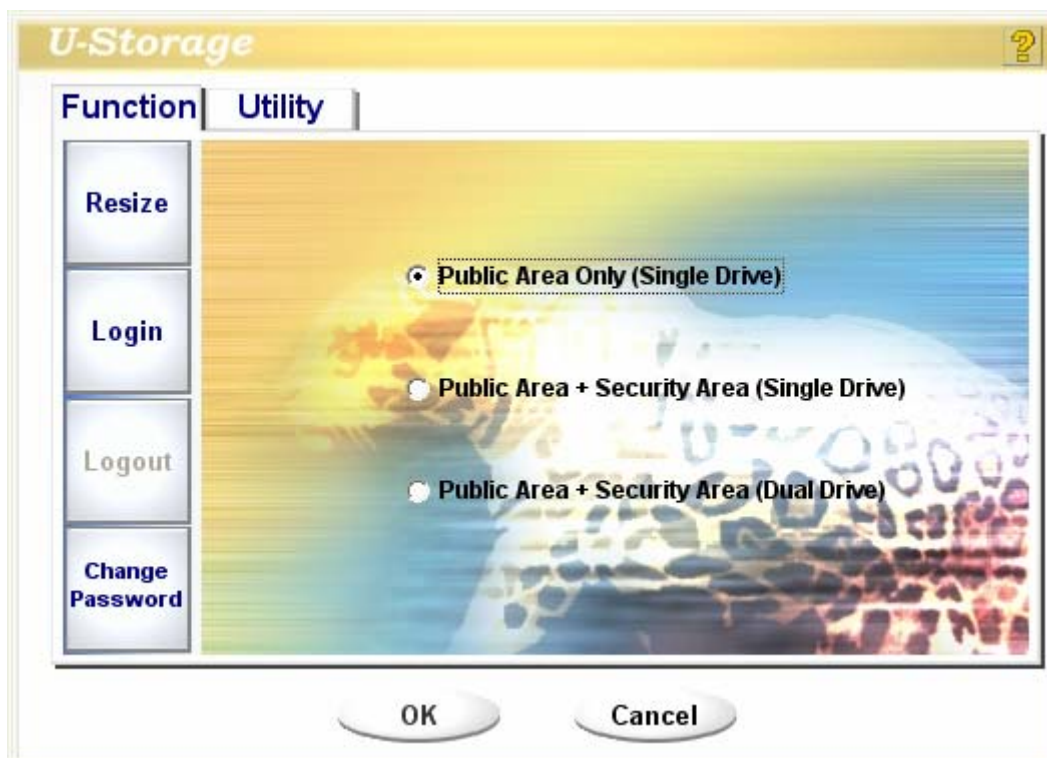

By default, the device is non-security. So, the “Resize” function will be active when you run this software first time.

### U-Storage - Resize:

As described in the “Partition Type” section, you can do the “Resize” action to your U-Storage.



#### Warning

The “Resize” action will erase all the data or files existing in U-Storage. The action is not reversible. You

have to backup all the important files or data. Also, please close all the active programs and windows on the screen of your computer.

1. Click the Resize button in the U-Storage manager window. The following “Resize Partition” window will pop up.



2. Select the partition type you want.
3. If you select the “Public Area Only”, then click the [OK] button. The “Confirmation” window will pop up. Please make sure you already backup all the important files or data.

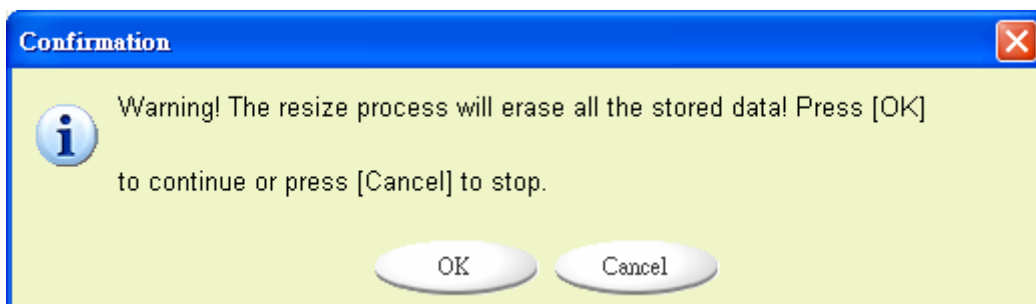

4. If you select the “Security Area”, then the following “Security Area Resize” window will pop up. You can drag the scroll bar in the middle of the window to set the size of the “Public Area” and “Security Area”. Or you can type in the size of each Zone you want in the “Size” window. You can set the password for accessing the security area in the “New Password” window. The maximum size of the password is 8 characters. You can key in the hint of your new password in the “Password Hint” window. This hint will be displayed when you click the “Hint” button in the “Unlock Protect” window. The maximum size of the Hint is 32 characters. After you finished the setting, click the [OK] button. The “Confirmation” window will pop up. Please make sure you already backup all the important files or data.



5. If you select the “Public Area + Security Area”, then the following “Public/Security Area Resize” window will pop up. You can drag the scroll bar in the window to set the size of each area. First, please set the size of the “Public Area” of LUN1. The minimum size for each area is 1MB. The maximum size of the “Public Area” of LUN1 is 1/4 of the total size. Once the size of the “Public Area” of LUN1 was set, the scroll bar of the “Public Area” and “Security Data Zone” of LUN0 will be set in the middle automatically. Or you can type in the size of each Zone you want in the “Size” window. You can set the password for accessing the security area in the “New Password” window. The maximum size

of the password is 8 characters. You can key in the hint of your new password in the “Password Hint” window. This hint will be displayed when you click the “Hint” button in the “Unlock Protect” window. The maximum size of the Hint is 32 characters. After you finish the setting, click the [OK] button. The “Confirmation” window will pop up. Please make sure you already backup all the important files or data.

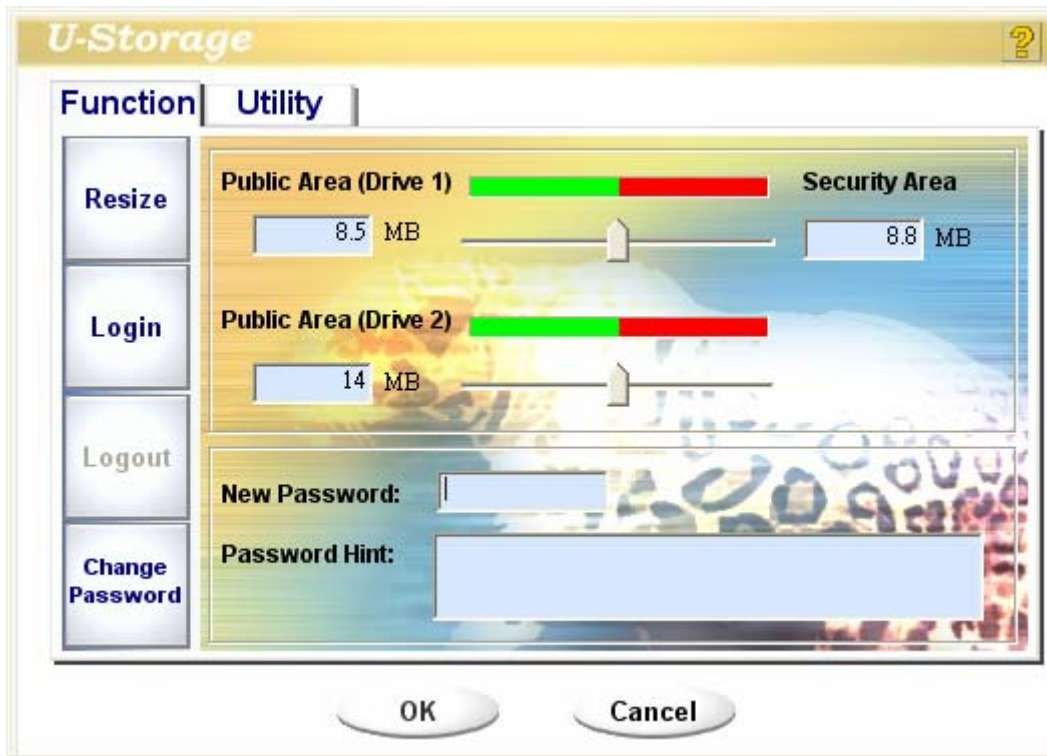

6. Once the resizing is finished, the following message will pop up.

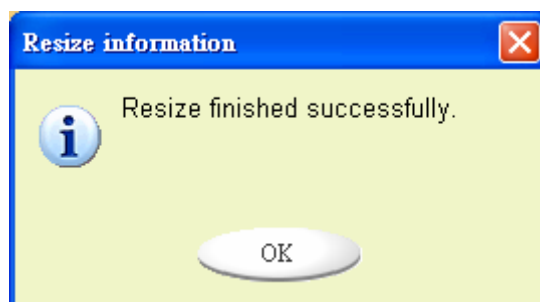

7. After you finish the “Resize”, the “Setup.exe” program will be copied into the “Public Area” (in LUN 0) automatically. It’s removable. However, it is needed when you insert your device into another computer. It will install the U-Storage software for you in the computer.

## Login the Security Area:

If you partition the device with security, you can execute the following “Login” function to access the security Area.

1. Double click the U-Storage icon in the notification window or click the [Login] button in the U-Storage manager window. The “Unlock Protect” window will pop up.

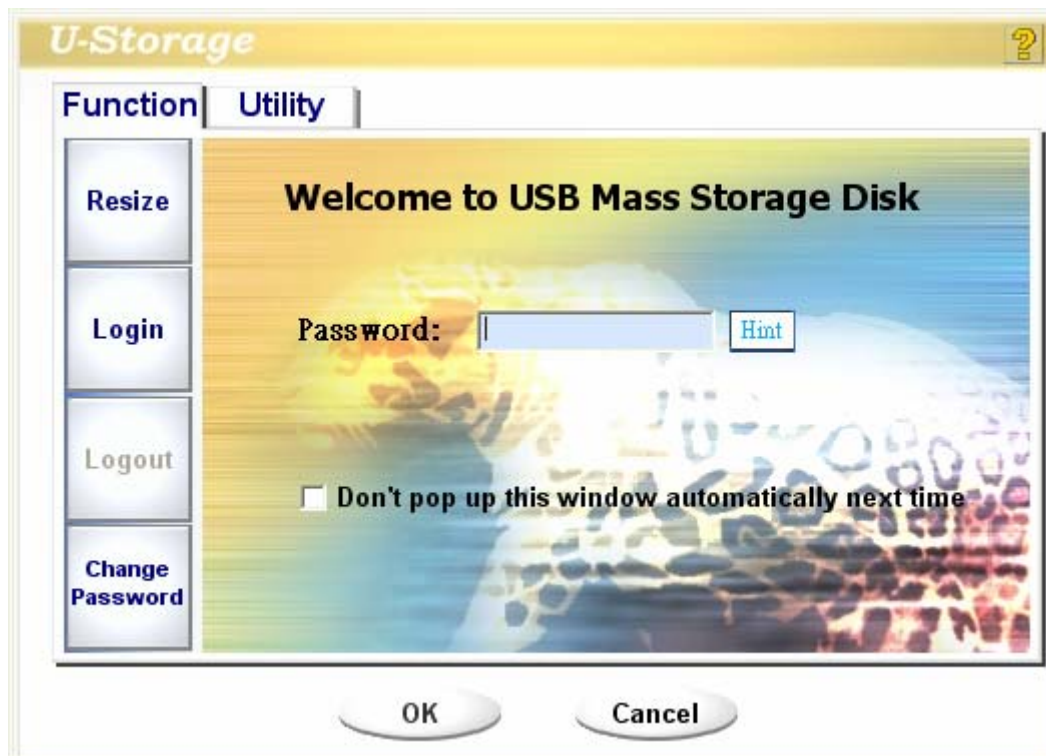

### Warning

When you do the login and logout action with the device, please make sure there is no application or program running or document unclosed on the device. If so, it will cause data loss or damage.

2. Key in the password in the “Password” area.
  - You can create the password hint in the “Resize” or “Change Password” functions. Once you create the password hint, you can click on the “Hint” button in the “Unlock Protect” window to prevent you from forgetting the password. The hint will be shown for three seconds.

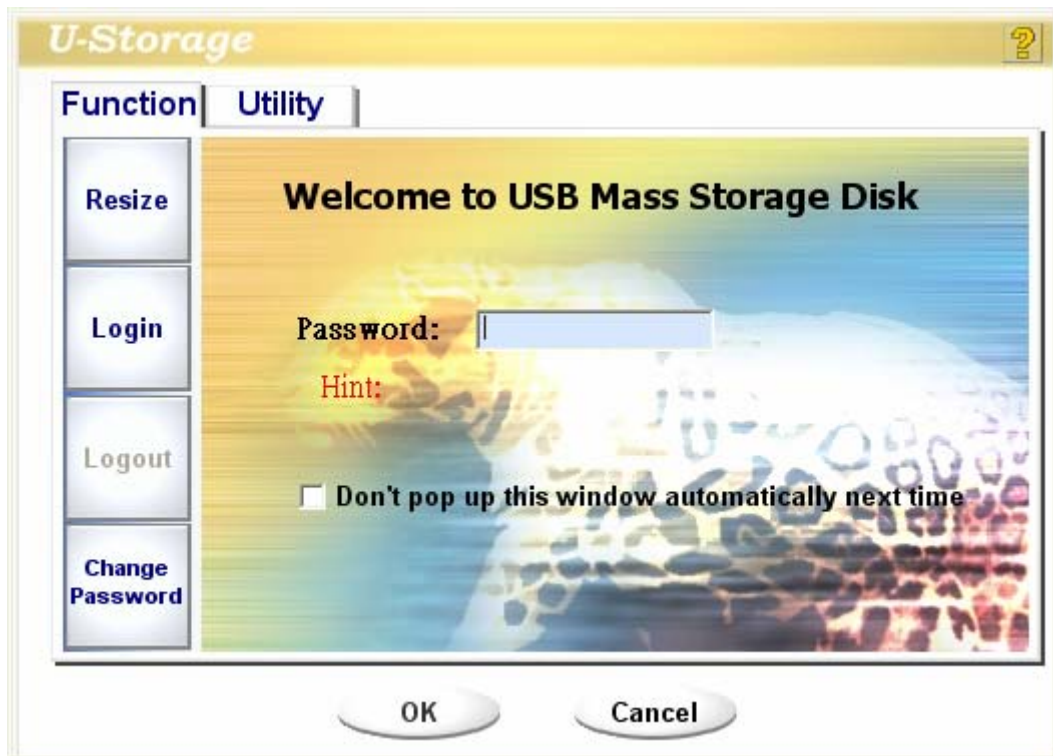

- If you key in the wrong password, the following message will be shown.



- You have three tries to input the password. After three tries, the following message will pop up. And you have to unplug and plug the device in order to do future actions.

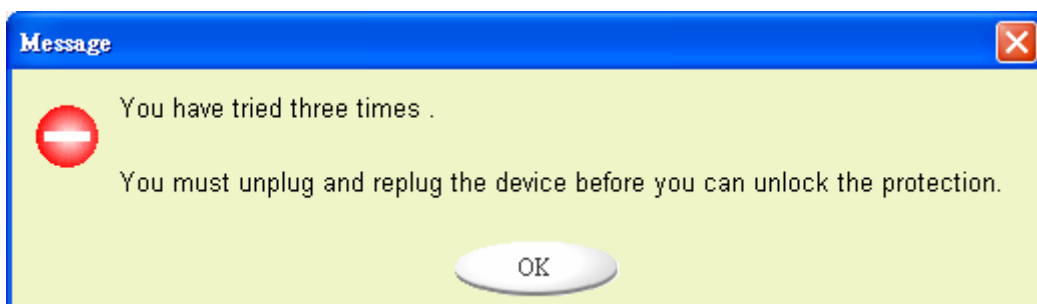

- When you do the login or logout action, please make sure you close all the programs or documents open connection on the device. If there is some application programs running or documents unclosed on the device, the following message will pop up. In Win2000, even the “file manager” has accessed the device it will be treated as “busy”. You have to close the file manager in order to do the “Login”. However, not all the connection could be checked in all kind of OS.

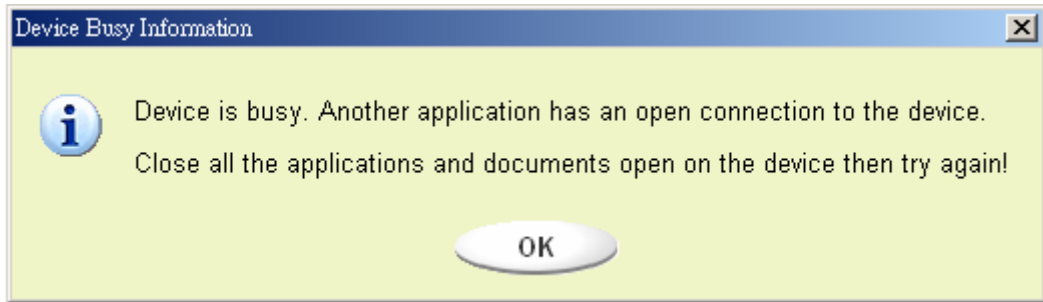

3. Click on the [OK] button.
4. Once the file manager window contains the “Security Area” pops up, you can do the operation you want with the Security Area. The file manager window will be like the following figure. The background is colorful.

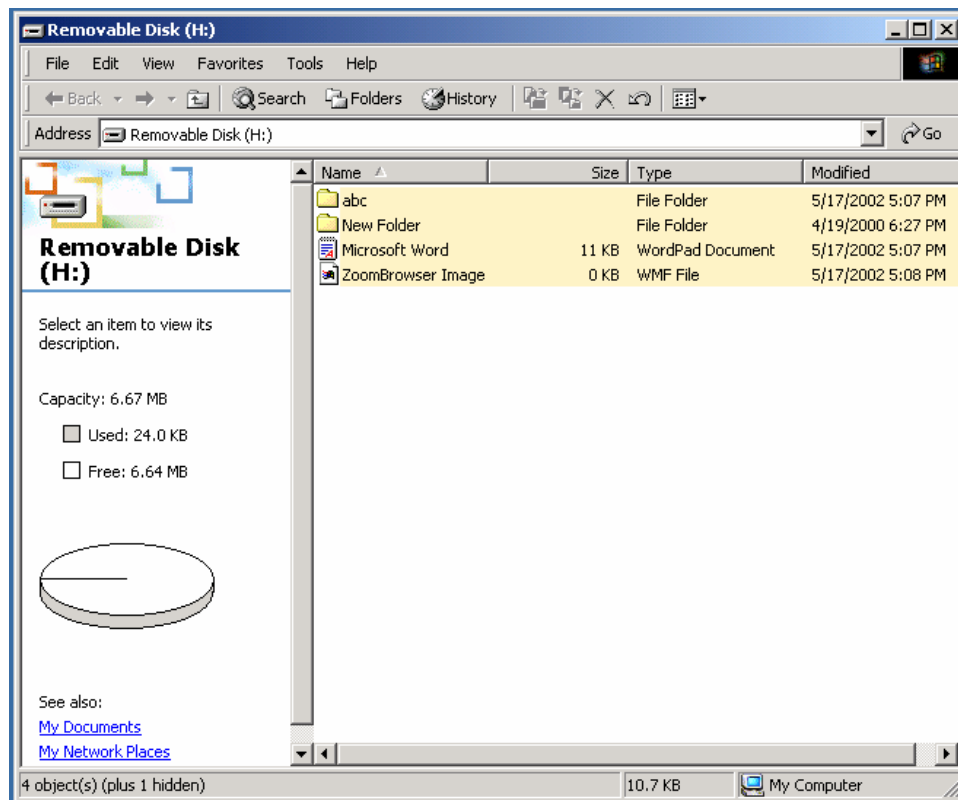

## Logout the Security Data Zone:

1. Double click the U-Storage icon in the notification window or select the [Logout] button in the U-Storage manager window.



### Warning

When you do the login and logout action with the device, please make sure there is no applications running or documents unclosed on the device. If so, it will cause data lose or damage.

- When you do the login or logout action, please make sure you have closed all the programs or documents on the device. If there are any programs running or documents unclosed on the device, the following message will pop up. In Win2000, even the “file manager” has accessed the device it will be treated as “busy”. You have to close the file manager in order to do the “Login”. However, not all the connection could be checked in all kind of OS.

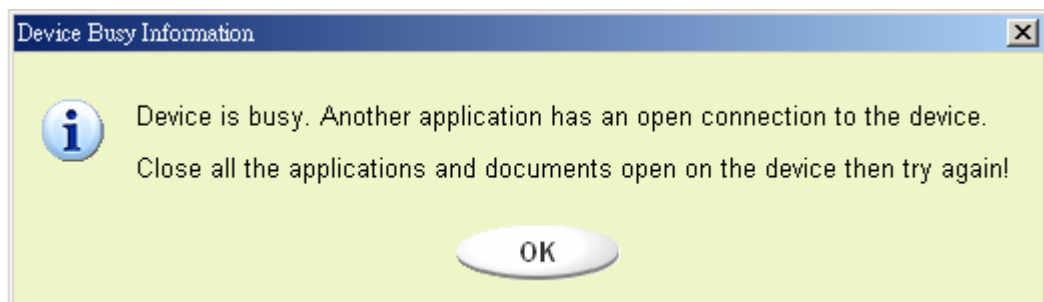

2. Once the file manager window contains the “Public Area” pop up, you can do the operation you want with the Public Area.

## Change Password:

User can change password and key in the password hint using the “Change Password” selection in the U-Storage menu. You can only select this item in “Security AP Zone”.

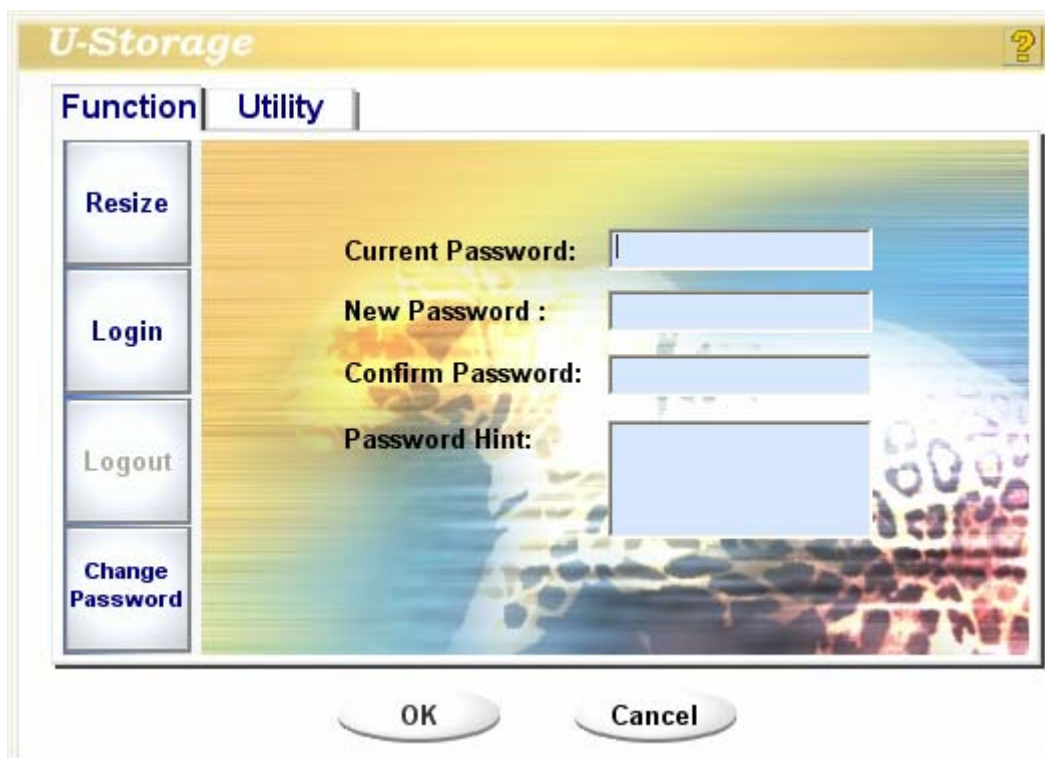

The screenshot shows the 'U-Storage' utility menu. The 'Utility' tab is selected, and the 'Change Password' option is highlighted in blue. The main area displays four input fields: 'Current Password:', 'New Password:', 'Confirm Password:', and 'Password Hint:'. The 'Change Password' button is also highlighted in blue. At the bottom, there are 'OK' and 'Cancel' buttons.

1. Make sure the “Write Protect” switch is in “OFF” location.
2. Key in your current password in the “Current Password” area.
3. Then, key in your new password and confirm in the “Confirm Password” area.
  - The maximum size of the password is 8 characters.
4. You can key in the hint of your new password in the “Password Hint” window. This hint will be displayed when you click the “Hint” button in the “Unlock Protect” window.

## Boot Up Function

The BootUp program in “Utility” manager window will build up the device as a bootable disk. Before you run the program, please do the following preparations,

- 1) This program can run under Windows 98 SE, XP, and ME. (The program can't be supported in Windows 2000.)
- 2) Please turn off the anti-virus program during the procedure.
- 3) Make sure your Windows system was located in C Disk.
- 4) Make sure the “write-protect” switch is in “OFF” position.
- 5) This program only deals with one device at the same time.
- 6) Make sure your U-Storage is in “Public Area” if it is with “Security” function.
- 7) If you want to make your device as a bootable USB HDD, you can't make the device as a “Security” one. This option is only supported in Windows 98 SE.



### Warning



If you performed the “Log In” action with your U-Storage and located in “Security Area” and run the BootUp function, it will do the “Log Out” and erase all the data in “Public Area”.

When you are ready to process, follow the following procedures, the procedures for Windows XP is different from Windows 98 and ME. This program cannot be run in Windows 2000.

### Windows 98 SE and Windows ME:

- 1). You can click the [Utility] button in the U-Storage manager window to execute the BootUp utility.



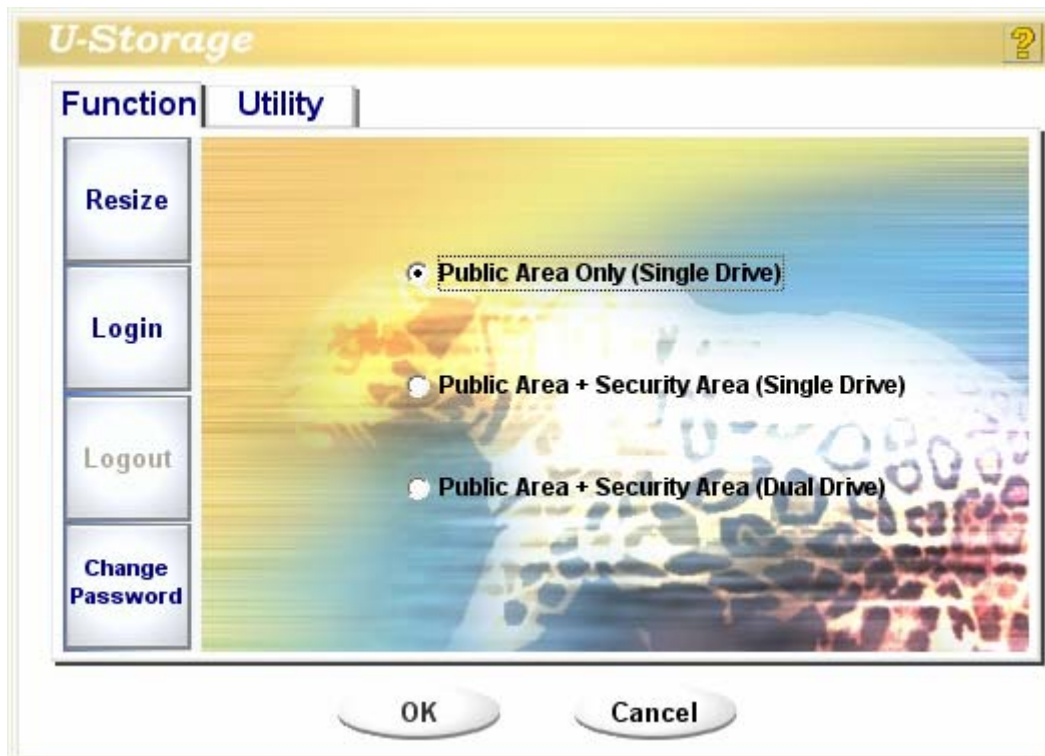

2). The following window will be showed up.

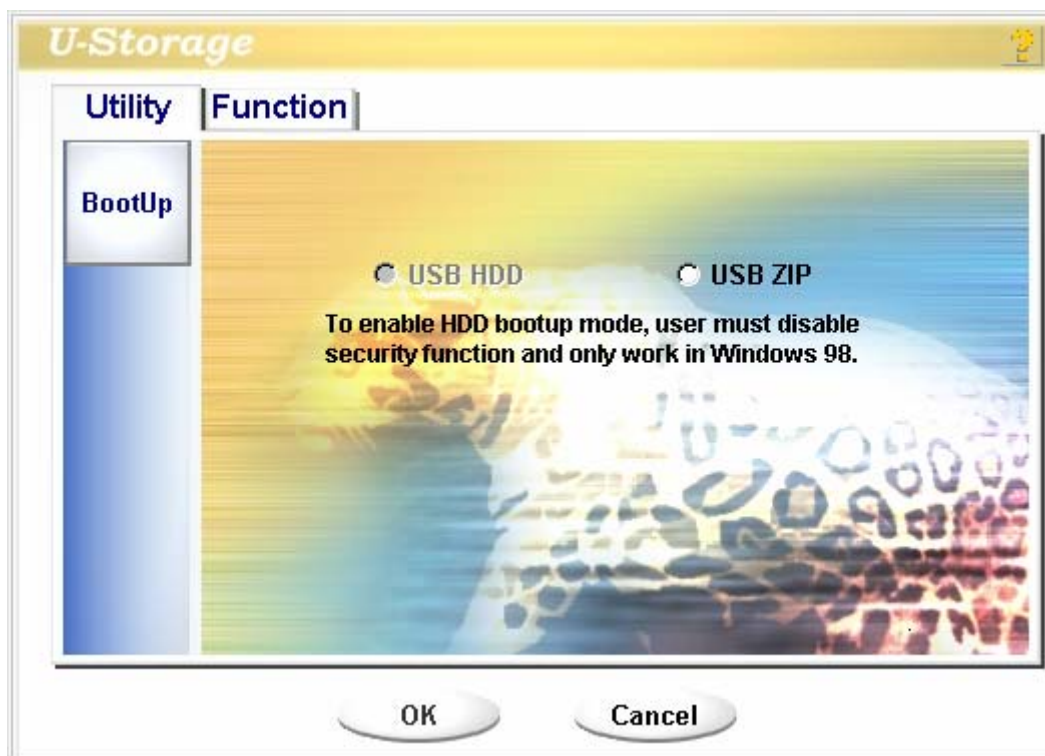

3). You can select the type of the boot up method, USB ZIP or USB HDD. The USB HDD is only for Windows 98.

- If you select “USB HDD”, the computer will get the **C : \>\_** prompt after you boot from the U-Storage.
  - If you select “USB ZIP”, the computer will get the **A : \>\_** prompt after you boot from the U-Storage.
  - If your device is with “Security” function, only USB ZIP can be selected.
- 4). After the selection, click the [OK] button. The following warning message will be shown. The data in the “Public Area” will be lost. If it is OK, click the [OK] button to continue the process.



**Warning**

The program will do the format. The existing data in the “Public Area”, which you want to make, will be lost.

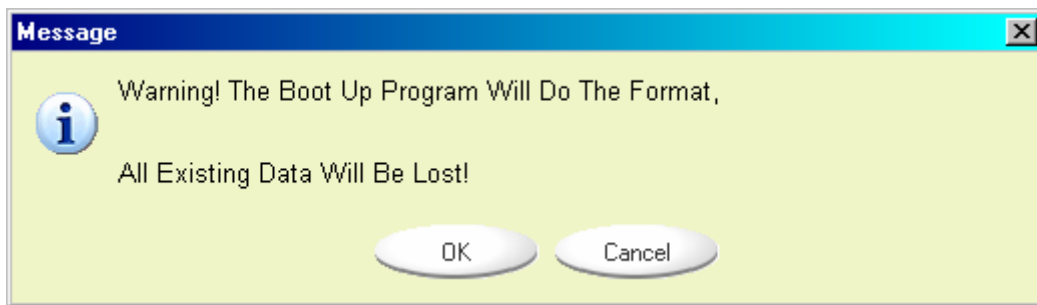

- 5). After the process is completed done, the finish message will be shown.



**Windows XP:**

- 1). Please make a bootable floppy first. You can insert a floppy into the floppy drive. Then, click on the icon of 3.5” floppy in the “My Computer” window by using the right button of the mice. Select the “Format” item.
- 2). Select the item for build up a bootable floppy in the format options. Then, click on the [Start] button.
- 3). Click on the [Utility] button in the U-Storage manager window. Then, select the USB ZIP. Click on the [OK] button.

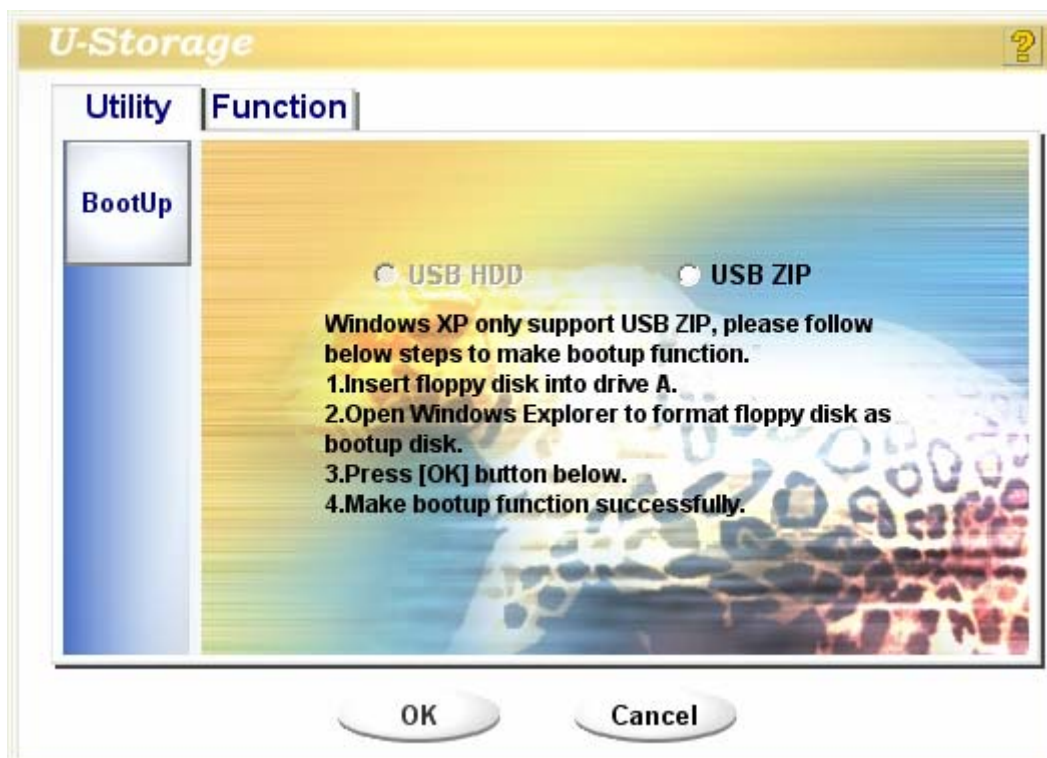

- 4). After the process is completed, the finish message will be shown.

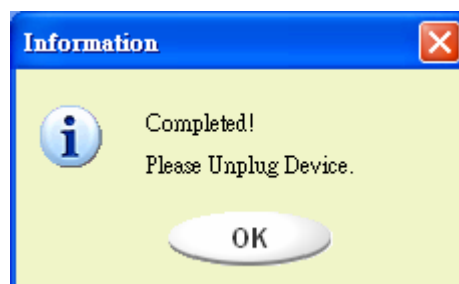

## Error Messages:

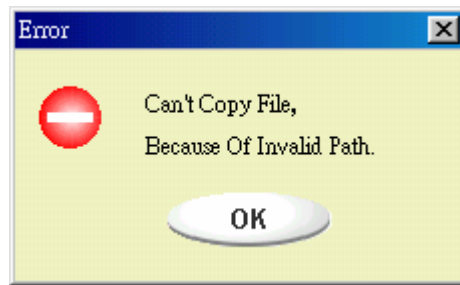

When this message shows up, the possible reason is your Windows OS installation is not completed. (Please make sure the path \WINDOWS\COMMAND\EBD in Windows 98, \WINDOWS\COMMAND\EBD in Windows ME, or \XP\_Bootable in Windows XP is exists)



When this message shows up, please make sure the "Write-Protect" switch is at "OFF" position.

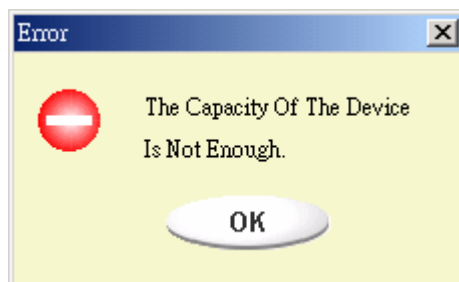

When this message shows up, please make sure the capacity of the "Public Area" is enough.

## Notes:

- After you finish the program, you will see different disk property when you select different disk type. For example, if you select it as "USB HDD", you will see the hard disk icon in the file manager window. If you select it as "USB ZIP", you will see the removable disk icon in the file manager window. However, only Windows 2000 and above can identify the difference. In Windows 98, you just

can see the “Removable Disk”.

- After you finish the program, the device contains the files necessary for boot up function. Please don't remove any file in this area. Otherwise it will cause failure when you do the boot up procedure of your computer.
- When you want to use the U-Storage to boot up your computer, please select the appropriate setting of the BIOS. Please refer to the user manual of the motherboard.
- Since the BIOS design of each motherboard is quite different, we cannot guarantee the boot up device is suitable for every computer.
- Since Award changed their BIOS spec. In March 2002, the boot up procedure is different from before. We cannot identify if the BIOS is new or old. So, this boot up utility is not suitable for Award's new BIOS if you use USB ZIP boot up option.

## Recover Disk

Once your device is damaged, you can use this utility to recover the device. It will check if there are too many bad block in device and try to repair it.

- 1). After you double click on the RecoverDisk shortcut in start menu, the following window will be pop up.

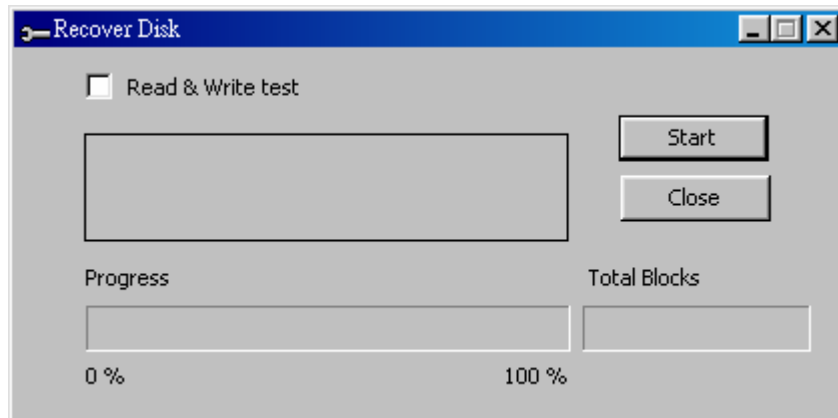

### **Warning**

The “Recover Disk” action will erase all the data or files existing in U-Storage. The action is not reversible. You have to backup all the important files or data.

- 2). There are two steps in Recover Disk, one is scan bad block and the other is “Read/Write” testing for each block. It will take a long time to scan each

block. It will take about 1.5 minutes for each 16 MB.

- 3). After you click the [Start] button in the window, the Recover process will be started.
- 4). Once the job is finished, the complete message will be shown in the middle area, or else it will show error message.

## Known Problems

**Problem:** The “Write-Protect” switch can not work on-line on Macintosh computer with Mac OS 10.1.4.



**Warning** If you switch the “Write-Protect” on-line with Mac OS 10.1.4, it will cause the computer system hang when you do the read or write operation.

**Workaround:** Disconnect the device when you need to switch the “Write-Protect” with Mac OS 10.1.4. We will solve the system hang-up problem in the near future. However, due to the OS operation issue, we don’t recommend you switch the “Write-Protect” on-line.

## **Disclaimer**

We made every effort to ensure that the information and procedure in this guide is accurate and complete, no liability can be accepted for any errors or omissions. Ours Technology Inc. (OTI) reserves the right to make any changes without further notice to any products herein.

## **Trademark Acknowledgments**

- IBM is a registered trademark of international Business Machines Corporation.
- iBook and iMac are trademarks of Apple Computer, Inc.
- Macintosh, PowerBook, Power Macintosh are trademarks of Apple Computer, Inc.
- Microsoft, Windows, Windows 98, Windows ME, Windows 2000, and Windows XP are either registered trademarks of Microsoft Corporation in the United States and/or other countries.
- Other names and products not mentioned above may be registered trademarks of their respective companies.